

Rack Slide Rail

■ ASSAMBLING GUIDE ■

● Package Contents

| | | |
|-----------------|---|----|
| Right Rack Rail | x | 1 |
| Left Rack Rail | x | 1 |
| M5 Nut | x | 12 |
| M5 Flat Screw | x | 8 |
| M5 Screw | x | 4 |

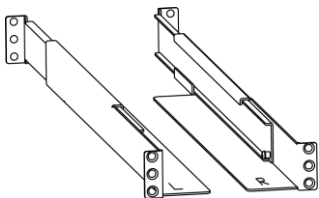

Left Rack Rail

Right Rack Rail



● Warning

- Do not place in an outdoor environment
- Keep away from fire, high salinity, corrosive environment
- Do not swallow anything of this product
- Please make sure every screws are fixed firmly when usage

● Installation

- **Rack installation overview:**

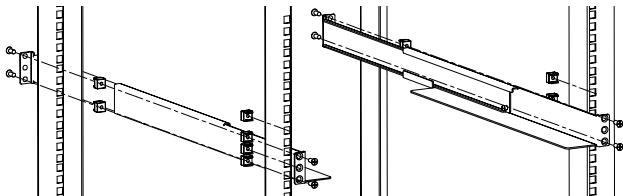

Step 1: Fix M5 Nuts as the picture shows

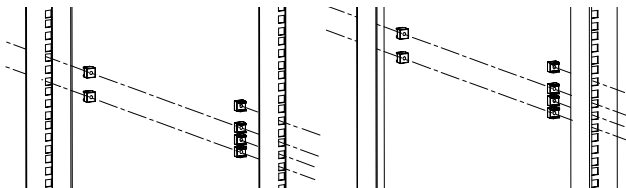

Step 2: Strengthen the Rack to fit the depth of the frame racks

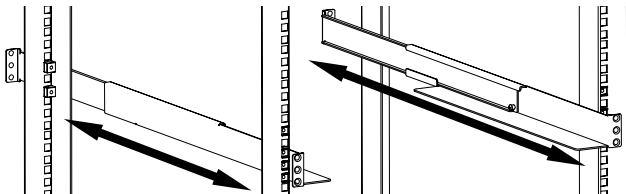

Step 3: Fix M5 Flat Screws as the picture shows

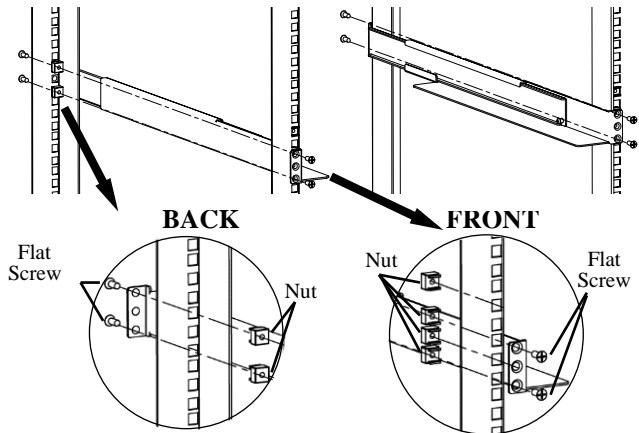

- **UPS installation overview:**

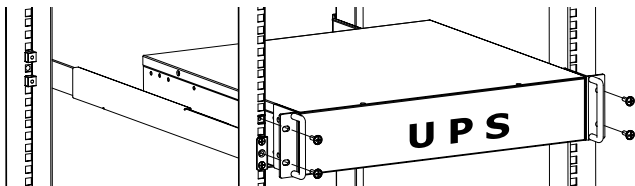

Step 1: Put UPS with assembled ears on the rack support.

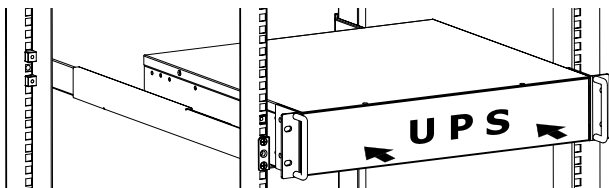

Step 2: Fix the M5 screws as the picture below shows.

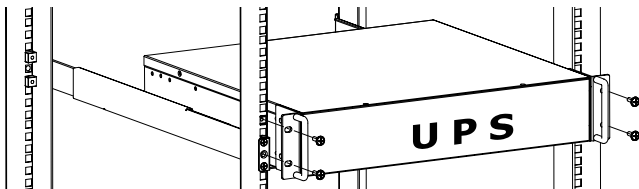

Step 3: The UPS is well installed on the rack.

